

Bulletin HY14-2701-B1/US

Series V10 Directional Control Valve

Effective: February 1, 2004
Supersedes: Cat. No. GPD-1000 dated 4/98

Description

The Parker Series V10 Sectional Directional Control Valves provide parallel or tandem circuit operation for open center and closed center systems. They offer economy and excellent performance in a compact design.

Specifications

Nominal Flow Rating ^①	15 GPM (56,7 liters/min)
Operating Pressure (maximum)	
Continuous Operating.....	3500 PSI (242 bar)
Work Port.....	5000 PSI (345 bar)
Exhaust Core.....	500 PSI (34,5 bar)
Operating Temperature	-40°F (-40°C) to +200°F (+93°C)
Standard Port Sizes ^②	
Inlet.....	SAE 10
Outlet.....	SAE 10
Power Beyond.....	SAE 10
Work Ports (Manual and Solenoid Work Sections).....	SAE 8
Fluid Compatibility	
Petroleum Based.....	60-1000 SSU (10-216 cST)
O-Ring Seals	Buna-N Standard (Optional Viton)
Spool Seals	Lip Type (Standard in 24990 Housings) O-Rings (Standard in 23592 Housings)
Filtration Required	10 micrometers (nominal)
Number of Work Sections	1-9
Weight (approx.)	
No. 23613 Inlet Cover.....	Approx. 5 lbs. (2,3 kg)
No. 23627 Outlet Cover.....	Approx. 5 lbs. (2,3 kg)
No. 24990 Work Section (Manual).....	Approx. 6 lbs. (2,8 kg)
No. 23962 Work Section (Solenoid).....	Approx. 8.5 lbs. (3,8 kg)
Mounting Position	Not Restricted

^① The maximum flow thru a directional control valve assembly is determined by the maximum allowable pressure drop acceptable to the application.

^② Contact the factory for other porting options (i.e. BSP)

Features

- Parallel and tandem work sections with individual load (reverse flow) checks
- Available for open center, closed center and power-beyond applications
- Low flow and high flow spool options available offering flows to 15 GPM (45 LPM)
- Continuous system operating pressures to 3500 PSI (Work port pressures to 5000 PSI)
- Utilizes many common components such as relief valves, spool positioners and handles with Series V11 and V16
- 3-Way, 4-Way and 4-Way Float operation
- Numerous manual spool positioner options plus remote hydraulic or electric solenoid operation
- Work port relief valves and anti-cavitation check valves available
- Single handle or dual function mechanical joystick control of manual sections
- Enclosed spool ends with handles
- Long life - low friction spool seals

PERFORMANCE CURVES

Open Center Pressure Drop

Typical pressure drop thru 1 to 9 section valve assemblies using Left (top or end) inlet to Right (top or end) outlet.

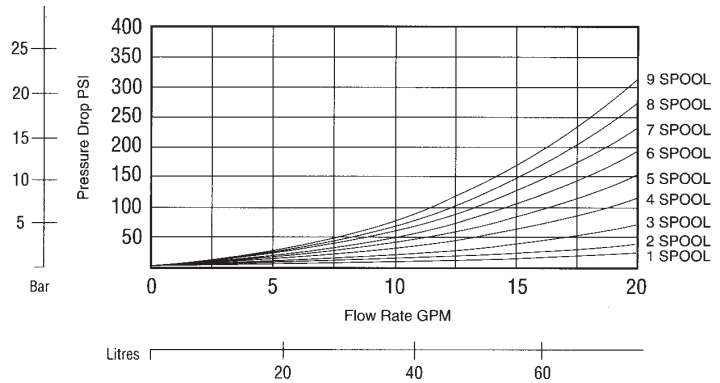

Inlet to Work Port

Typical pressure drop thru 1 to 9 section valve assemblies from Left (top or end) inlet to work port.

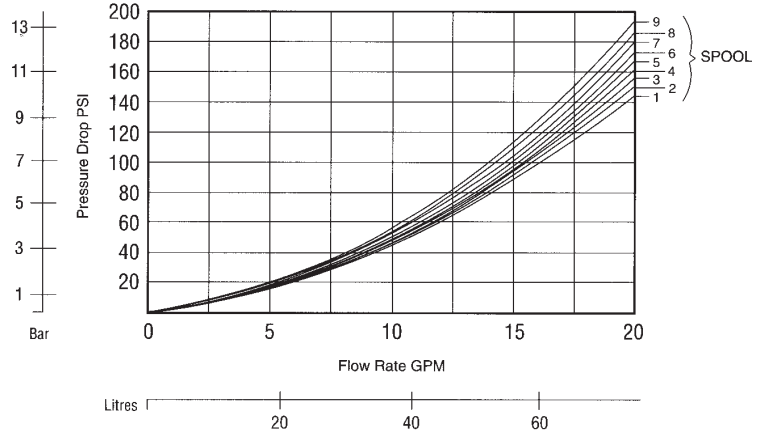

Work Port to Outlet

Typical pressure drop thru 1 to 9 section valve assemblies from work port to Right (top or end) outlet port.

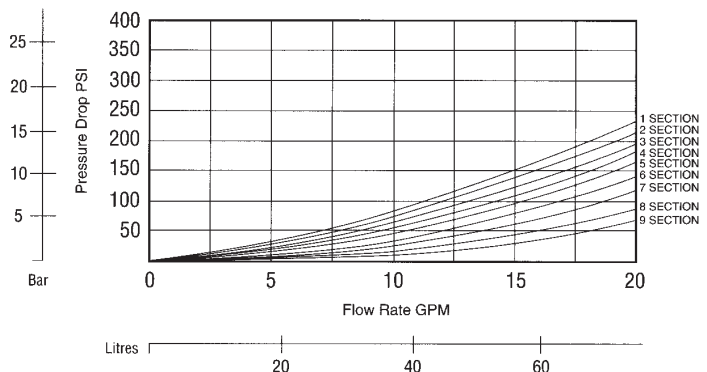

INLET COVERS

No. 23613 Inlet Covers

No. 23613 inlet cover is used for all model V10 control valve assemblies. It offers top and end inlet and outlet ports. All unused ports must be plugged.

This inlet cover also has the provision for the main relief valve.

If a gauge port is required, a port plug may be drilled and tapped for a 1/4" NPTF or SAE 4 and installed in the unused inlet port.

(Optional) machining is available for solenoid valve operation. Included in this machining is the cavity for the Pressure Reducing Valve and internal pilot passage.

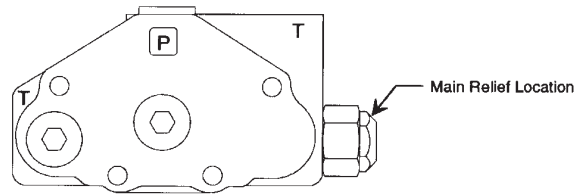

No. 23613 Inlet Cover for all Non-Solenoid Valves

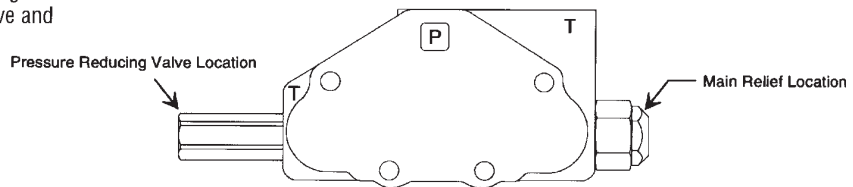

No. 23613 Inlet Cover for all Solenoid-Operated Valves

Main Relief Valves

The primary function of the main relief valve is to prevent excessive pressure spikes. Main relief valve cartridges are available in externally-adjustable (Model RCMA), or internal shim adjustable (Model RCM) configurations. Several relief springs are available for pressure settings within the 500 to 3500 PSI (34 to 242 bar) full pressure range.

When a main relief valve is not required, the No Relief Plug must be installed in place of the relief valve.

Model 'RCM' differential area relief valve is internally shim adjustable within the relief spring range. Several spring and shim options are available.

Model 'RCMA' differential area relief valve is externally screw adjustable within the spring range. Several spring options are available.

Pressure Reducing Valve

The pressure reducing valve (PRV) provides the reduced pilot pressure required for the solenoid actuators. The PRV is shim adjustable for maximum pressures of 300-500 PSI and is rated for maximum flow of 5 GPM.

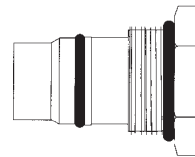
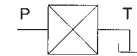

No Relief Cavity Plug

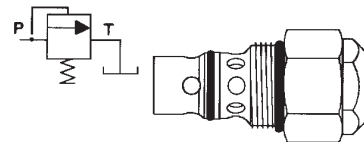

Model 'RCM' Relief Valve

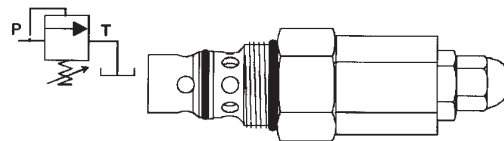

Model 'RCMA' Relief Valve

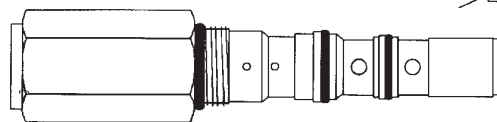
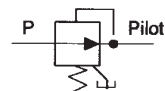

Pressure Reducing Valve

OUTLET COVERS

No. 23627 Outlet Cover

No. 26327 outlet cover is used for all model V10 control valve assemblies. It offers top and end ports.

The conversion port is located in the outlet cover.

Conversion port options include: turn around (outlet located in inlet cover), closed center, power beyond or solenoid pilot control valve.

Closed Center Plug (Closed Center Systems)

Install the closed center plug into the top conversion port when using a variable displacement pump. The closed center plug will block pump flow when all valve spools are in neutral. High pressure is maintained at the control valve inlet. The maximum system pressure is set with the compensator adjustment on the pump.

Power Beyond Sleeve (High Pressure Carry Over)

By installing the power beyond sleeve into the top conversion port, hydraulic oil under pressure will be carried thru the valve making it available to a second control valve. In a power beyond circuit, the upstream valve will always have priority. Hydraulic oil will only be available to the downstream valve when all valve spools in the upstream valve are in neutral.

Each control valve may have its own main relief valve set at different pressures, but the highest pressure setting must be in the upstream valve.

Solenoid Pilot Control Valve (Solenoid Valves Only)

The Solenoid Pilot Control Valve is required to increase the oil pressure in the open center core to 300 PSI (20,7 bar) above exhaust core pressure. The differential is required to maintain adequate pilot pressure to shift the valve spools.

This is a mechanical cartridge that requires no electrical connections. Pilot pressure is maintained at all times.

The solenoid pilot control valve is shim adjustable to increase pressure differential in low flow applications.

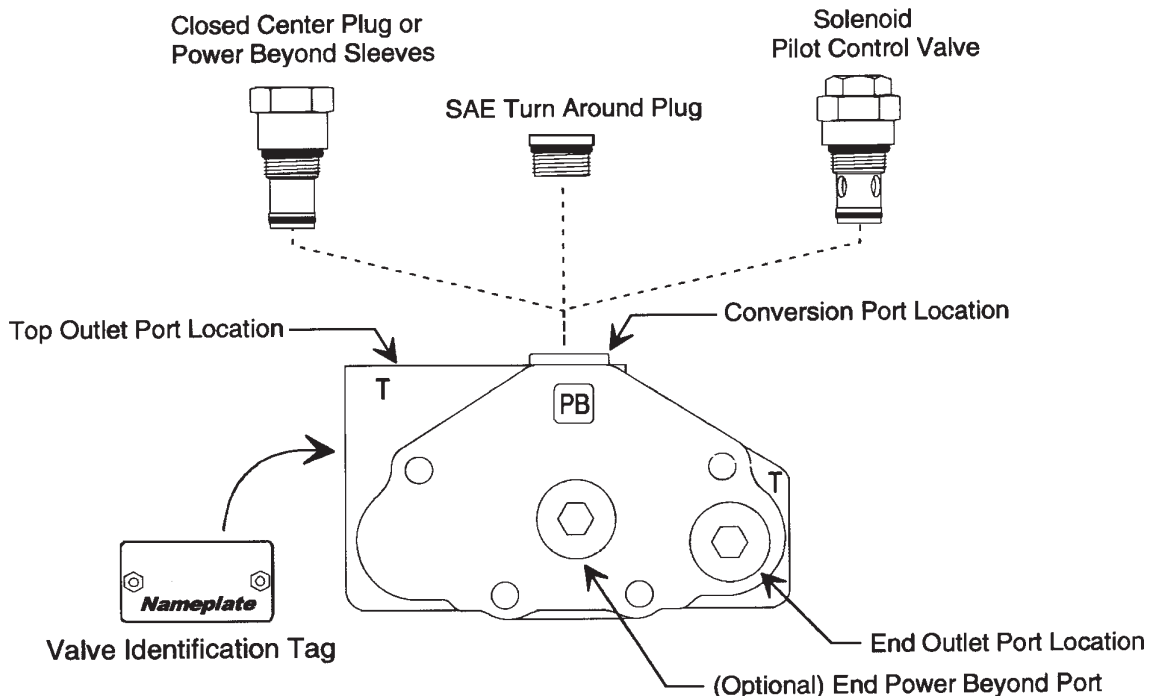

WORK SECTIONS

No. 23592 Housing (Prior to 1/98)
 No. 24990 Housing (New Style - Introduced 1/98)

Model V10 work sections are precisely machined from high tensile gray cast iron.

Valve spools may be operated manually, mechanically or by remote hydraulic or electric solenoid.

Two basic types of work sections are available:

- Parallel (open center or closed center)
- Tandem (priority circuit systems)

Low Flow and High Flow Valve Spools

Low flow and high flow valve spools are available for use in No. 24990 work sections. For optimum metering, select low flow spools for applications requiring 8 GPM (31 lpm) or less.

Use high flow spools for applications up to (15 GPM - 57 lpm) . Both low flow and high flow versions may be intermixed in the same valve assembly.

3-Way Cylinder Spool (03)

For control of single acting cylinders or uni-directional hydraulic motors where motor free-wheeling is not required. The active work port is blocked in the neutral position.

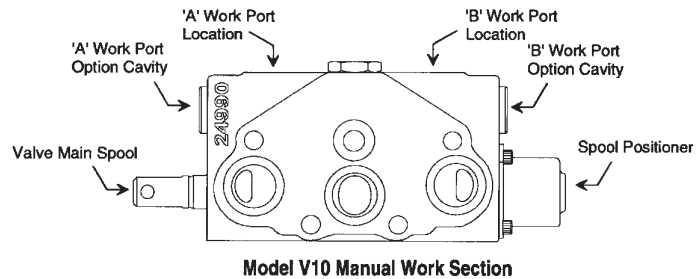

Model V10 Manual Work Section

4-Way Free Flow Motor Spool (F4)

For control of double acting cylinders or reversible hydraulic motors. Because both work ports are open to tank in the neutral position, free flow spools will allow a motor to coast.

Caution: If using this spool configuration in cylinder lift applications, it must be used in conjunction with a load holding device to prevent the load from free falling when the spool is in the neutral position.

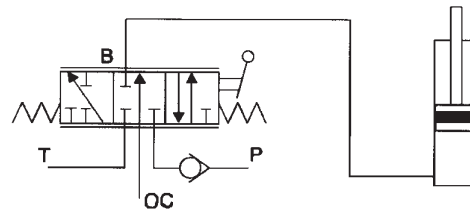

Typical 3-Way (03) Application

4-Way Cylinder Spool (04)

For control of double acting cylinders or reversible hydraulic motors where floating a cylinder or motor free-wheeling is not required. Both work ports are blocked in the neutral position.

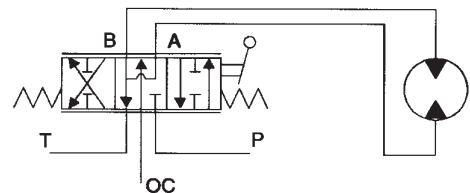

Typical 4-Way Free Flow (F4) Application

4-Way 4-Position Float Spool (K4)

This spool is the same as the 4-Way Cylinder spool, with the addition of a fourth 'Float' position. It is spring-centered to neutral from the 'A' and 'B' power positions.

The fourth position is the detented 'Float' position which allows a cylinder to float or a hydraulic motor to free wheel.

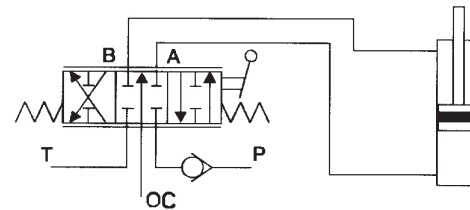

Typical 4-Way (04) Application

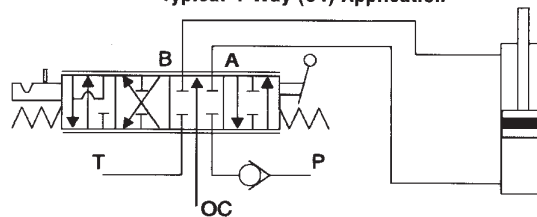

Typical 4-Way Float (K4) Application

WORK SECTIONS

Spool Positioners and Actuators

Spring Return Spool Positioner

The spring return spool positioner 'spring returns' the valve spool to neutral from the 'A' and 'B' power positions when the handle is released.



'D' Detent Spool Positioner

The 'D' detent spool positioner 'detents' the valve spool in neutral and the 'A' and 'B' power positions. The valve spool will remain in the position in which it was manually placed when the handle is released.

This option is NOT intended for use as a positive spool locking device against excessive external forces or machine vibration.

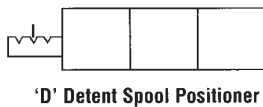

'K4' 4-Position Float Spool Positioner

The 'K' float positioner spring returns the valve spool to neutral from the 'A' and 'B' power positions. The fourth position is the detented - float position.

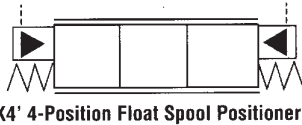

'HR' and 'HRO' Remote Spool Actuators

'HR' hydraulic remote spool actuators provide for remote hydraulic operation of two and three position V10 work sections.

A customer-supplied hydraulic controller (Gresen Model HCJ, HCS or equivalent), and a 300 to 500 PSI (20 to 33 bar) pilot source, will provide infinite spool positioning for metering work port flow.

'HRO' hydraulic remote spool actuators offer an external screw type override. This override provides a means for emergency manual operation in the event of pilot pressure failure. It may also be used as a Spool Travel Limiter.

All hydraulic remote actuator pilot ports are SAE 6 straight thread. Pilot ports may be located at the top (std), bottom, or end (end not available with external override).

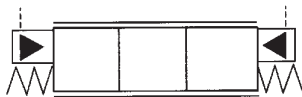

Hydraulic Remote Actuator Specifications

Max. Pressure Rating750 PSI (34.5 bar)
Pilot Press to Initiate Flow60 PSI (4.2 bar)
Pilot Pressure at Full Stroke220 PSI (15.2 bar)
Pilot Flow2 to 4 GPM (7.5 to 15 liters/min)

Work Port Relief Valves

The primary function of a work port relief valve is to limit a part of a circuit to a pressure less than the main relief setting. Port relief valves will also provide spike protection while the valve is in neutral. The relief setting at 'crack' or 'full flow' must be specified when ordering.

Model RP10 Work Port Relief Valves

Work port relief valves are available in adjustable (RP10-A) and tamper resistant (RP10-N) configurations, offering a pressure range from 500 to 3500 PSI (34 to 242 bar).

Adjustable and tamper resistant combination relief/anti-cavitation check cartridges (Model RP10-AAC and RP10-NAC) are also available.

The 'NR' no relief cavity plug must be installed in this cavity when a work port option is not required.

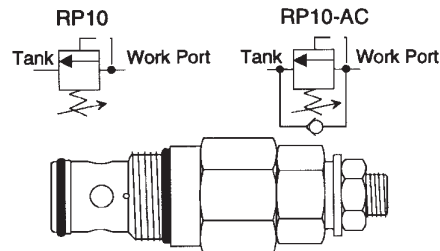

Anti-Cavitation Checks

Anti-cavitation (also referred to as anti-void) check valves are available for use in the work port option cavity to prevent cylinder or motor cavitation. It allows the cavitating work port to refill from the exhaust core.

Anti-Cavitation check valves are non-adjustable and will open whenever the work port pressure is lower than the exhaust core pressure.

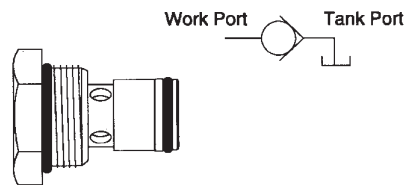

WORK SECTIONS

Handle End Options

The clevis (handle end) of the spool may be located at either the 'A' or 'B' port end of the work section. Unless otherwise specified, the handle end will be located at the 'A' port end for all work sections.

V10 valve spools may be reversed in the housing to offer 'B' port handle.

The following handle end options are available:

- **CVHA** (Complete Vertical Handle Assembly)
- **XCVHA** (Complete Extended Vertical Handle Assembly)
- **CHHA** (Complete Horizontal Handle Assembly)
- **XCHHA** (Complete Extended Horizontal Handle Assembly)
- **LCHA** (Less Complete Handle Assembly)

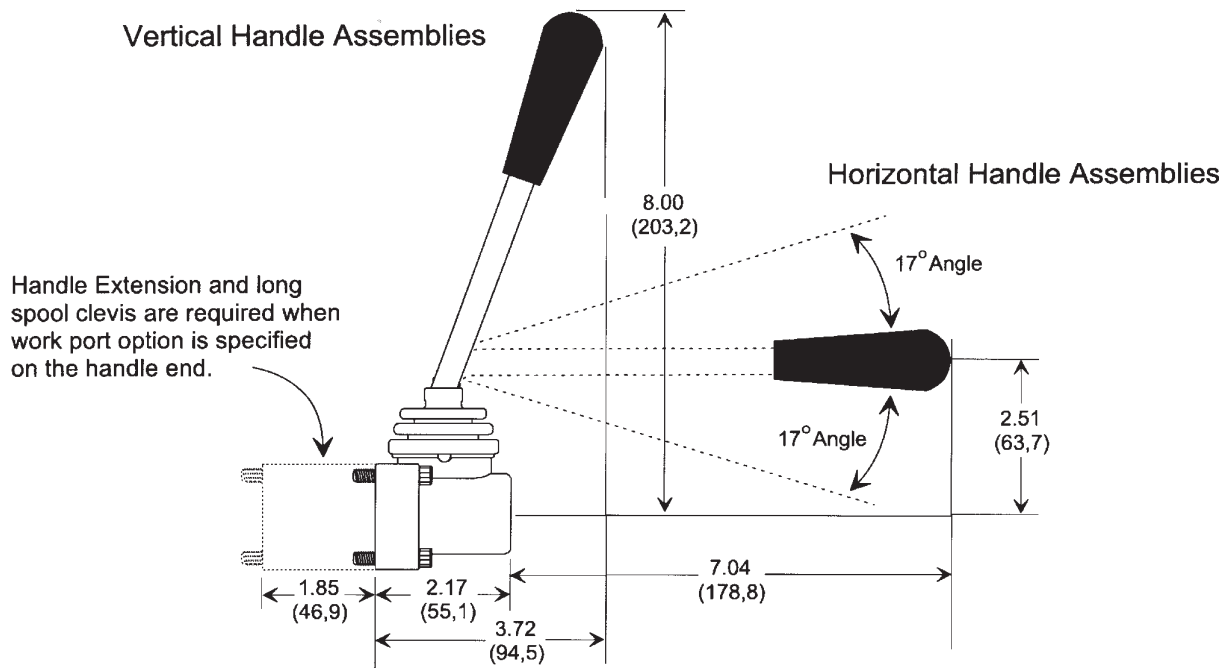

SOLENOID OPERATED WORK SECTIONS

Model V10 solenoid-operated work sections are precisely machined from high tensile gray cast iron.

Two basic types of work sections are available:

- Parallel section (open center or closed center)
- Tandem section (priority circuit systems)

Proportional (EPC) Electric Solenoid Actuators

The Proportional Solenoid Actuator contains two proportional solenoid-operated pressure reducing cartridges; one at each end of the control valve spool.

When the PWM signal is sent to a solenoid, a pilot pressure is directed to one end of the control valve spool. As the PWM % is increased or decreased, the pilot increases or decreases proportionally, giving main valve spool movement.

When both solenoids are de-energized, both ends of the control valve spool are open to exhaust and the spool is spring-centered to neutral.

On/Off (SOL) Electric Solenoid Actuators

The On/Off Solenoid Actuator option contains solenoid-operated valve cartridges; one at each end of the control valve spool.

When a solenoid is energized, the cartridge directs pilot pressure to one end of the control valve spool causing the spool to shift full stroke from its neutral position.

When both solenoids are de-energized, both ends of the control valve spool are open to exhaust and the spool is spring-centered to neutral.

Optional spool travel limiters are available to adjust maximum spool shift.

Electric Solenoid Actuator Specifications

Electrical Requirements

Operating Voltage12VDC or 24VDC
Coil Resistance@ 68°F (20°C)
12V Proportional (1.6 Amp)7.5 ohms
24V Proportional (.8 Amp)30 ohms
12V On/Off Solenoid (1.8 Amp)6.5 ohms
24V On/Off Solenoid (.9 Amp)26.6 ohms
Signal (for proportional solenoid)PWM, 50 Hz frequency

Hydraulic Pilot Supply Requirements

Minimum Pressure250 PSI (17 bar)*
*Above control valve exhaust core pressure	
Maximum Pressure750 PSI (52 bar)
Flow (minimum)1.5 GPM (5,7 liters/min)
Filtration Required10 Micron (nominal)
Response TimeLess than 150 milliseconds
(Neutral to full flow or full flow to zero flow)	

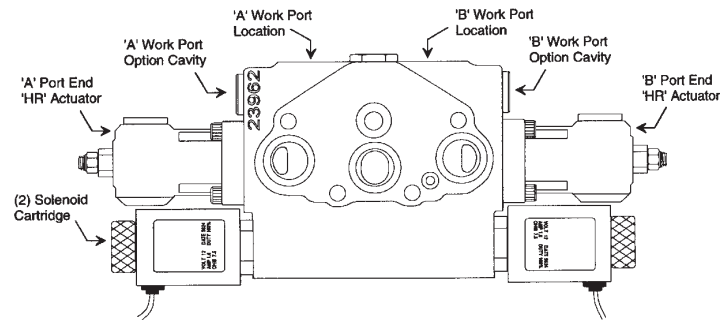

Model V10 Solenoid-Operated Work Section

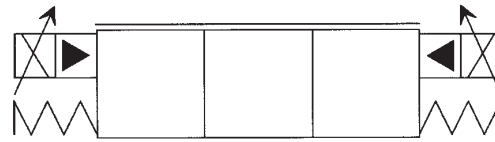

Proportional (EPC) Electric Solenoid Actuator



On/Off (SOL) Electric Solenoid Actuators

DIMENSIONS

Manually Operated Control Valve Assembly

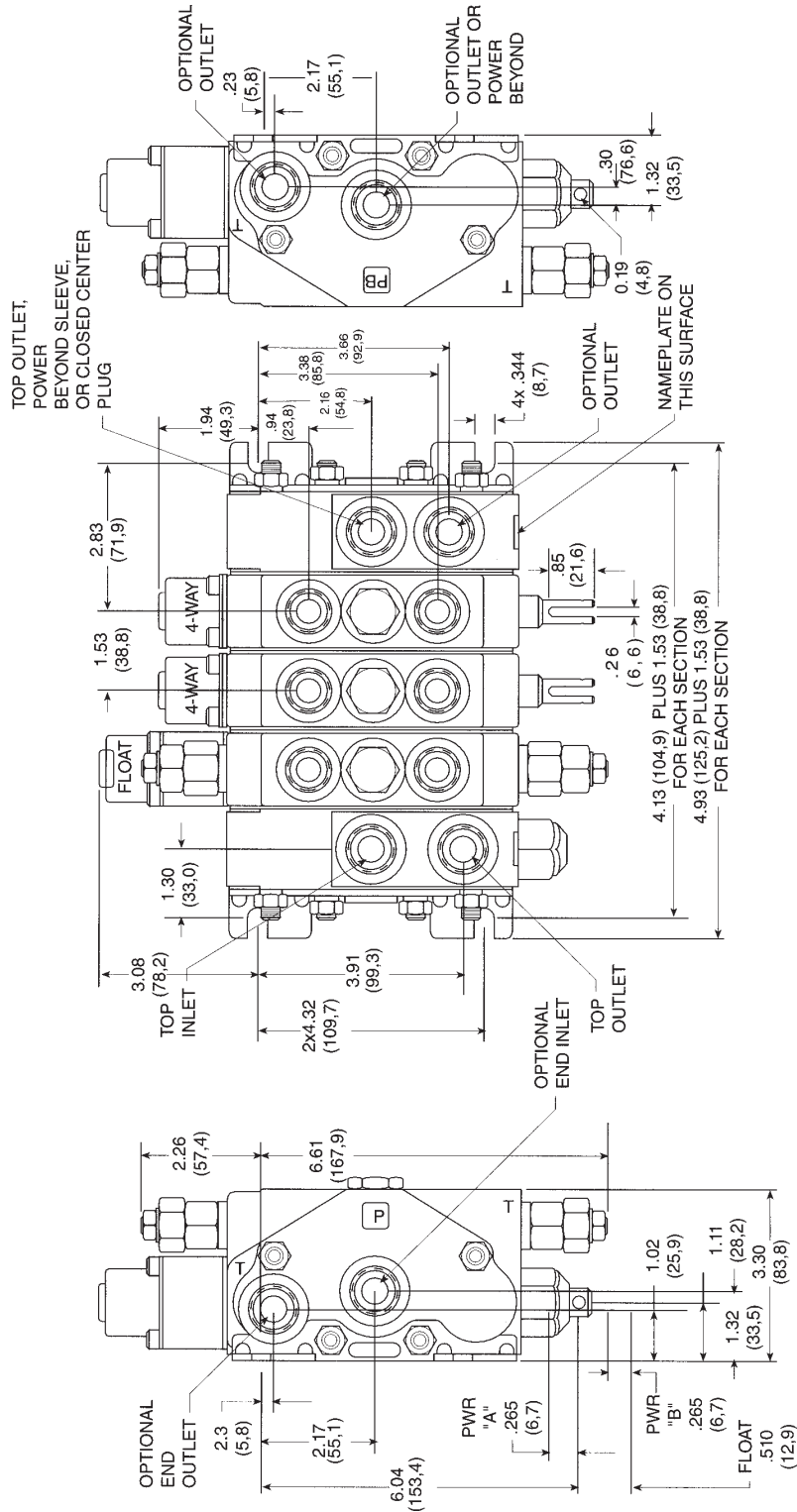

DIMENSIONS ARE IN INCHES (MILLIMETERS) AND ARE FOR REFERENCE ONLY.

DIMENSIONS

Solenoid Operated Directional Control Valve Assembly

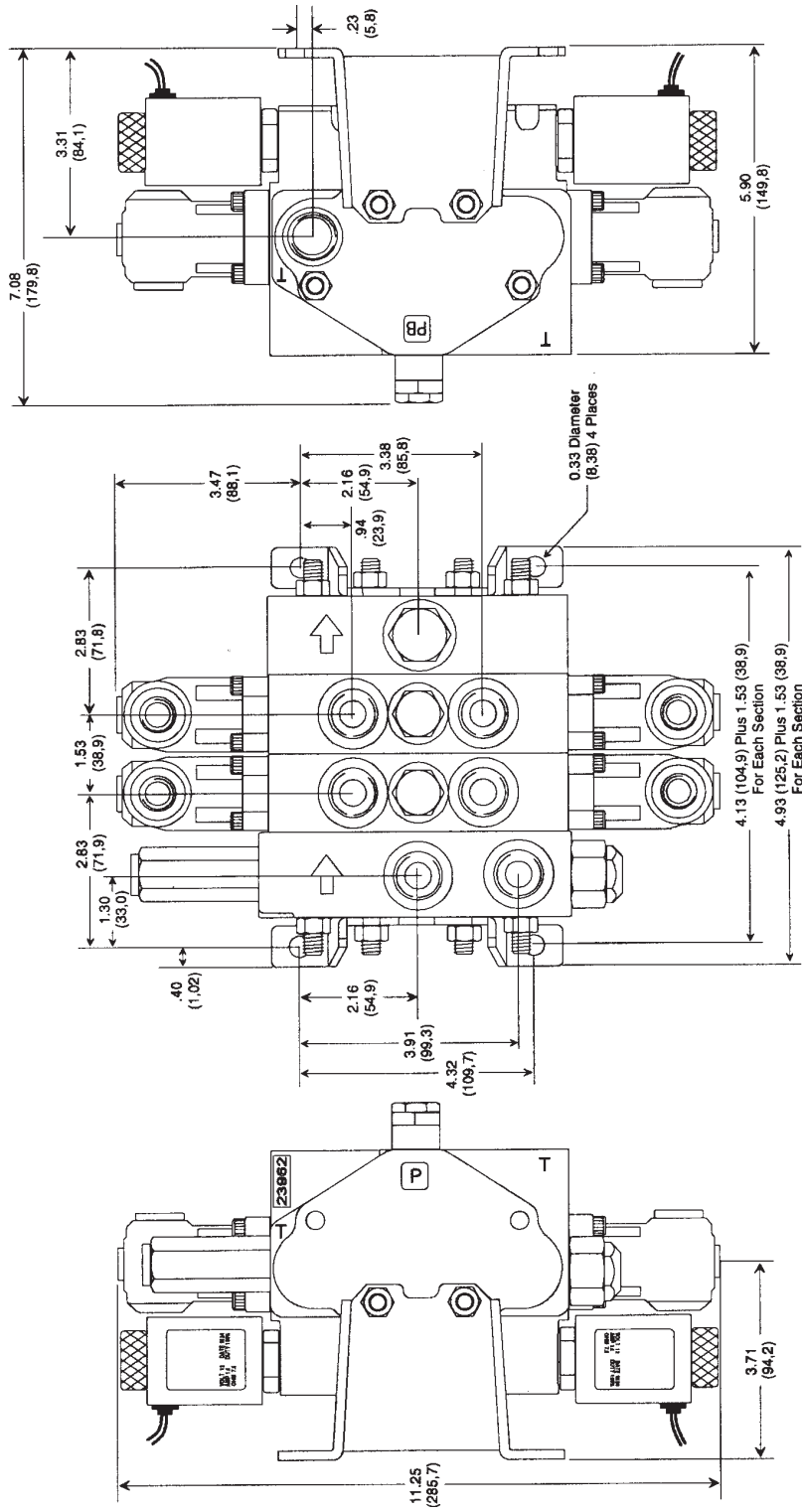

DIMENSIONS ARE IN INCHES (MILLIMETERS) AND ARE FOR REFERENCE ONLY.

DIRECTIONAL CONTROL VALVE ASSEMBLY FORM

LEFT COVER		CENTER SECTIONS					RIGHT COVER					
HOUSING NO.	PORT LOCATION	PORT SIZE	#1	#2	#3	#4	#5	#6	#7	#8	HOUSING NO.	
IN	OUT										OUTLET	OUTLET PORT SIZE
CIRCUIT			<input type="checkbox"/>	<input type="checkbox"/>	<input type="checkbox"/>	<input type="checkbox"/>	<input type="checkbox"/>	<input type="checkbox"/>	<input type="checkbox"/>	<input type="checkbox"/>	<input type="checkbox"/>	<input type="checkbox"/>
PARALLEL			<input type="checkbox"/>	<input type="checkbox"/>	<input type="checkbox"/>	<input type="checkbox"/>	<input type="checkbox"/>	<input type="checkbox"/>	<input type="checkbox"/>	<input type="checkbox"/>	<input type="checkbox"/>	<input type="checkbox"/>
TANDEM			<input type="checkbox"/>	<input type="checkbox"/>	<input type="checkbox"/>	<input type="checkbox"/>	<input type="checkbox"/>	<input type="checkbox"/>	<input type="checkbox"/>	<input type="checkbox"/>	<input type="checkbox"/>	<input type="checkbox"/>
SERIES			<input type="checkbox"/>	<input type="checkbox"/>	<input type="checkbox"/>	<input type="checkbox"/>	<input type="checkbox"/>	<input type="checkbox"/>	<input type="checkbox"/>	<input type="checkbox"/>	<input type="checkbox"/>	<input type="checkbox"/>
LOAD SENSE			<input type="checkbox"/>	<input type="checkbox"/>	<input type="checkbox"/>	<input type="checkbox"/>	<input type="checkbox"/>	<input type="checkbox"/>	<input type="checkbox"/>	<input type="checkbox"/>	<input type="checkbox"/>	<input type="checkbox"/>
3-Way (Handle End Work Port is Plugged as Standard)			<input type="checkbox"/>	<input type="checkbox"/>	<input type="checkbox"/>	<input type="checkbox"/>	<input type="checkbox"/>	<input type="checkbox"/>	<input type="checkbox"/>	<input type="checkbox"/>	<input type="checkbox"/>	<input type="checkbox"/>
4-Way			<input type="checkbox"/>	<input type="checkbox"/>	<input type="checkbox"/>	<input type="checkbox"/>	<input type="checkbox"/>	<input type="checkbox"/>	<input type="checkbox"/>	<input type="checkbox"/>	<input type="checkbox"/>	<input type="checkbox"/>
4-Way Float (K)			<input type="checkbox"/>	<input type="checkbox"/>	<input type="checkbox"/>	<input type="checkbox"/>	<input type="checkbox"/>	<input type="checkbox"/>	<input type="checkbox"/>	<input type="checkbox"/>	<input type="checkbox"/>	<input type="checkbox"/>
FOR FA SECT.			<input type="checkbox"/>	<input type="checkbox"/>	<input type="checkbox"/>	<input type="checkbox"/>	<input type="checkbox"/>	<input type="checkbox"/>	<input type="checkbox"/>	<input type="checkbox"/>	<input type="checkbox"/>	<input type="checkbox"/>
CHECK ONE			<input type="checkbox"/>	<input type="checkbox"/>	<input type="checkbox"/>	<input type="checkbox"/>	<input type="checkbox"/>	<input type="checkbox"/>	<input type="checkbox"/>	<input type="checkbox"/>	<input type="checkbox"/>	<input type="checkbox"/>
GAGE PORT PLUGGED <input type="checkbox"/> 1/4 NPT <input type="checkbox"/> SAE4 <input type="checkbox"/>			<input type="checkbox"/>	<input type="checkbox"/>	<input type="checkbox"/>	<input type="checkbox"/>	<input type="checkbox"/>	<input type="checkbox"/>	<input type="checkbox"/>	<input type="checkbox"/>	<input type="checkbox"/>	<input type="checkbox"/>
SYSTEM OPERATES AT:			<input type="checkbox"/>	<input type="checkbox"/>	<input type="checkbox"/>	<input type="checkbox"/>	<input type="checkbox"/>	<input type="checkbox"/>	<input type="checkbox"/>	<input type="checkbox"/>	<input type="checkbox"/>	<input type="checkbox"/>
G.P.M. Max. _____ PSI Max. _____			<input type="checkbox"/>	<input type="checkbox"/>	<input type="checkbox"/>	<input type="checkbox"/>	<input type="checkbox"/>	<input type="checkbox"/>	<input type="checkbox"/>	<input type="checkbox"/>	<input type="checkbox"/>	<input type="checkbox"/>
MAIN RELIEF INFORMATION			<input type="checkbox"/>	<input type="checkbox"/>	<input type="checkbox"/>	<input type="checkbox"/>	<input type="checkbox"/>	<input type="checkbox"/>	<input type="checkbox"/>	<input type="checkbox"/>	<input type="checkbox"/>	<input type="checkbox"/>
Relief Model _____			<input type="checkbox"/>	<input type="checkbox"/>	<input type="checkbox"/>	<input type="checkbox"/>	<input type="checkbox"/>	<input type="checkbox"/>	<input type="checkbox"/>	<input type="checkbox"/>	<input type="checkbox"/>	<input type="checkbox"/>
Set at _____ PSI			<input type="checkbox"/>	<input type="checkbox"/>	<input type="checkbox"/>	<input type="checkbox"/>	<input type="checkbox"/>	<input type="checkbox"/>	<input type="checkbox"/>	<input type="checkbox"/>	<input type="checkbox"/>	<input type="checkbox"/>
<input type="checkbox"/> Crack, or			<input type="checkbox"/>	<input type="checkbox"/>	<input type="checkbox"/>	<input type="checkbox"/>	<input type="checkbox"/>	<input type="checkbox"/>	<input type="checkbox"/>	<input type="checkbox"/>	<input type="checkbox"/>	<input type="checkbox"/>
<input type="checkbox"/> Full Flow @ _____ GPM			<input type="checkbox"/>	<input type="checkbox"/>	<input type="checkbox"/>	<input type="checkbox"/>	<input type="checkbox"/>	<input type="checkbox"/>	<input type="checkbox"/>	<input type="checkbox"/>	<input type="checkbox"/>	<input type="checkbox"/>
No Relief (NR) <input type="checkbox"/>			<input type="checkbox"/>	<input type="checkbox"/>	<input type="checkbox"/>	<input type="checkbox"/>	<input type="checkbox"/>	<input type="checkbox"/>	<input type="checkbox"/>	<input type="checkbox"/>	<input type="checkbox"/>	<input type="checkbox"/>
HANDLE END INFORMATION			<input type="checkbox"/>	<input type="checkbox"/>	<input type="checkbox"/>	<input type="checkbox"/>	<input type="checkbox"/>	<input type="checkbox"/>	<input type="checkbox"/>	<input type="checkbox"/>	<input type="checkbox"/>	<input type="checkbox"/>
A PORT END <input type="checkbox"/>			<input type="checkbox"/>	<input type="checkbox"/>	<input type="checkbox"/>	<input type="checkbox"/>	<input type="checkbox"/>	<input type="checkbox"/>	<input type="checkbox"/>	<input type="checkbox"/>	<input type="checkbox"/>	<input type="checkbox"/>
B PORT END <input type="checkbox"/>			<input type="checkbox"/>	<input type="checkbox"/>	<input type="checkbox"/>	<input type="checkbox"/>	<input type="checkbox"/>	<input type="checkbox"/>	<input type="checkbox"/>	<input type="checkbox"/>	<input type="checkbox"/>	<input type="checkbox"/>
POSITION			<input type="checkbox"/>	<input type="checkbox"/>	<input type="checkbox"/>	<input type="checkbox"/>	<input type="checkbox"/>	<input type="checkbox"/>	<input type="checkbox"/>	<input type="checkbox"/>	<input type="checkbox"/>	<input type="checkbox"/>
Handle P/N _____			<input type="checkbox"/>	<input type="checkbox"/>	<input type="checkbox"/>	<input type="checkbox"/>	<input type="checkbox"/>	<input type="checkbox"/>	<input type="checkbox"/>	<input type="checkbox"/>	<input type="checkbox"/>	<input type="checkbox"/>
Bracket P/N _____			<input type="checkbox"/>	<input type="checkbox"/>	<input type="checkbox"/>	<input type="checkbox"/>	<input type="checkbox"/>	<input type="checkbox"/>	<input type="checkbox"/>	<input type="checkbox"/>	<input type="checkbox"/>	<input type="checkbox"/>
Spool Boots _____			<input type="checkbox"/>	<input type="checkbox"/>	<input type="checkbox"/>	<input type="checkbox"/>	<input type="checkbox"/>	<input type="checkbox"/>	<input type="checkbox"/>	<input type="checkbox"/>	<input type="checkbox"/>	<input type="checkbox"/>
WORK PORT #1			<input type="checkbox"/>	<input type="checkbox"/>	<input type="checkbox"/>	<input type="checkbox"/>	<input type="checkbox"/>	<input type="checkbox"/>	<input type="checkbox"/>	<input type="checkbox"/>	<input type="checkbox"/>	<input type="checkbox"/>
Work Port Relief [Specify Model]			<input type="checkbox"/>	<input type="checkbox"/>	<input type="checkbox"/>	<input type="checkbox"/>	<input type="checkbox"/>	<input type="checkbox"/>	<input type="checkbox"/>	<input type="checkbox"/>	<input type="checkbox"/>	<input type="checkbox"/>
Setting (PSI) at Full Flow or Crack			<input type="checkbox"/>	<input type="checkbox"/>	<input type="checkbox"/>	<input type="checkbox"/>	<input type="checkbox"/>	<input type="checkbox"/>	<input type="checkbox"/>	<input type="checkbox"/>	<input type="checkbox"/>	<input type="checkbox"/>
Anti-Cavitation Check			<input type="checkbox"/>	<input type="checkbox"/>	<input type="checkbox"/>	<input type="checkbox"/>	<input type="checkbox"/>	<input type="checkbox"/>	<input type="checkbox"/>	<input type="checkbox"/>	<input type="checkbox"/>	<input type="checkbox"/>
WORK PORT #2			<input type="checkbox"/>	<input type="checkbox"/>	<input type="checkbox"/>	<input type="checkbox"/>	<input type="checkbox"/>	<input type="checkbox"/>	<input type="checkbox"/>	<input type="checkbox"/>	<input type="checkbox"/>	<input type="checkbox"/>
Work Port Relief [Specify Model]			<input type="checkbox"/>	<input type="checkbox"/>	<input type="checkbox"/>	<input type="checkbox"/>	<input type="checkbox"/>	<input type="checkbox"/>	<input type="checkbox"/>	<input type="checkbox"/>	<input type="checkbox"/>	<input type="checkbox"/>
Setting (PSI) at Full Flow or Crack			<input type="checkbox"/>	<input type="checkbox"/>	<input type="checkbox"/>	<input type="checkbox"/>	<input type="checkbox"/>	<input type="checkbox"/>	<input type="checkbox"/>	<input type="checkbox"/>	<input type="checkbox"/>	<input type="checkbox"/>
Anti-Cavitation Check			<input type="checkbox"/>	<input type="checkbox"/>	<input type="checkbox"/>	<input type="checkbox"/>	<input type="checkbox"/>	<input type="checkbox"/>	<input type="checkbox"/>	<input type="checkbox"/>	<input type="checkbox"/>	<input type="checkbox"/>
WORK PORT #3			<input type="checkbox"/>	<input type="checkbox"/>	<input type="checkbox"/>	<input type="checkbox"/>	<input type="checkbox"/>	<input type="checkbox"/>	<input type="checkbox"/>	<input type="checkbox"/>	<input type="checkbox"/>	<input type="checkbox"/>
Work Port Relief [Specify Model]			<input type="checkbox"/>	<input type="checkbox"/>	<input type="checkbox"/>	<input type="checkbox"/>	<input type="checkbox"/>	<input type="checkbox"/>	<input type="checkbox"/>	<input type="checkbox"/>	<input type="checkbox"/>	<input type="checkbox"/>
Setting (PSI) at Full Flow or Crack			<input type="checkbox"/>	<input type="checkbox"/>	<input type="checkbox"/>	<input type="checkbox"/>	<input type="checkbox"/>	<input type="checkbox"/>	<input type="checkbox"/>	<input type="checkbox"/>	<input type="checkbox"/>	<input type="checkbox"/>
Anti-Cavitation Check			<input type="checkbox"/>	<input type="checkbox"/>	<input type="checkbox"/>	<input type="checkbox"/>	<input type="checkbox"/>	<input type="checkbox"/>	<input type="checkbox"/>	<input type="checkbox"/>	<input type="checkbox"/>	<input type="checkbox"/>
FUNCTION OF SECTION			<input type="checkbox"/>	<input type="checkbox"/>	<input type="checkbox"/>	<input type="checkbox"/>	<input type="checkbox"/>	<input type="checkbox"/>	<input type="checkbox"/>	<input type="checkbox"/>	<input type="checkbox"/>	<input type="checkbox"/>
REMARKS:			<input type="checkbox"/>	<input type="checkbox"/>	<input type="checkbox"/>	<input type="checkbox"/>	<input type="checkbox"/>	<input type="checkbox"/>	<input type="checkbox"/>	<input type="checkbox"/>	<input type="checkbox"/>	<input type="checkbox"/>

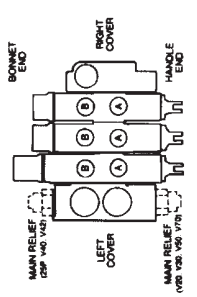

ORDERING CODE

Options Code Symbol

Inlet Cover Options

No. 23613 Inlet Cover Machining

Top and End Inlet Ports (Standard)
 Top and End Outlet Ports (Standard)

Main (Inlet) Relief Options

Differential Area, Internal Shim Adjustable . . . RCM
 Differential Area, External Screw Adjustable . . RCMA
 Relief Cavity Plug (No Relief) K-10-NR

Outlet Cover Options

No. 23627 Outlet Cover Machining

Top and End Outlet Ports (Standard)
 Top Conversion Port (Standard)
 Top or End Power Beyond Capability (Standard)

Outlet Conversion Port Options

Closed Center Plug K-10-C
 SAE 8 (Top) Power Beyond Sleeve K-10-8-Y
 SAE 10 (Top) Power Beyond Sleeve K-10-10-Y
 Solenoid Pilot Control Cartridge K-10-P

Work Section Options

Manual Work Section

24990 Housing (Available 1/1998)
 23592 Housing (Prior to 1/1998)
 Parallel V10P-
 Tandem V10T-

No. 23962 Solenoid Work Section

On/Off Solenoid Operation SOL-I
 Proportional Solenoid Operation EPC-I

Options Code Symbol

Spool Variations[Ⓞ]

3-Way, 3-Position[Ⓞ] 03
 4-Way, 3-Position[Ⓞ] 04
 4-Way, 3-Position Free Flow[Ⓞ] F4
 4-Way, 4-Position Float[Ⓞ] K4

[Ⓞ] Also available in low flow spool versions.

Spool Action Options

Spring Return To Neutral (Standard)
 3-Position Detent D
 1- or 2- Position Detent with Spring ReturnRI, RO, or RIO
 4-Position Float with Detent K4
 Hydraulic Remote Actuator HR
 Hydraulic Remote Actuator with Override HR0
 On/Off Solenoid Actuator SOL-I
 Proportional Solenoid Actuator EPC-I
 Travel Limiter/Spool Override (for SOL and EPC)

Work Port Reliefs and Anti-Cavitation Checks

Relief Cavity Plug (No Relief) K-10-NR-WP
 Anti-Cavitation Check Valve K-10-AC
 Pilot Operated Relief Valve (Ext. Adj.) RP10-A
 Relief Valve (Tamper Resistant) RP10-N
 Combination Relief & Anti-Cav (Ext. Adj.) RP10-AAC
 Combination Relief & A/C (Tamper Resistant) . . . RP10-NAC

Handle End Options

Complete Vertical Handle Assembly CVHA
 Complete Extended Vertical Handle Assembly . . .XCVHA[Ⓞ]
 Complete Standard Horizontal Handle Assembly .CHHA
 Complete Extended Horizontal Handle Assembly .XCHHA[Ⓞ]
 Less Complete Handle Assembly LCHA
 Mechanical Joystick (Left Hand Version) MJA-2L
 Mechanical Joystick (Right Hand Version) MJA-2R

[Ⓞ] Handle Assembly includes and extended handle bracket for use when RP10 port relief is used on the handle end of work section.

⚠ WARNING

FAILURE OR IMPROPER SELECTION OR IMPROPER USE OF THE PRODUCTS AND/OR SYSTEMS DESCRIBED HEREIN OR RELATED ITEMS CAN CAUSE DEATH, PERSONAL INJURY AND PROPERTY DAMAGE.

This document and other information from Parker Hannifin Corporation, its subsidiaries and authorized distributors provide product and/or system options for further investigation by users having technical expertise. It is important that you analyze all aspects of your application and review the information concerning the product or system in the current product catalog. Due to the variety of operating conditions and applications for these products or systems, the user, through its own analysis and testing, is solely responsible for making the final selection of the products and systems and assuring that all performance, safety and warning requirements of the application are met.

The products described herein, including without limitation, product features, specifications, designs, availability and pricing, are subject to change by Parker Hannifin Corporation and its subsidiaries at any time without notice.

Offer of Sale

The items described in this document are hereby offered for sale by Parker Hannifin Corporation, its subsidiaries or its authorized distributors. This offer and its acceptance are governed by the provisions stated in the "Offer of Sale".

© Copyright 2004, Parker Hannifin Corporation, All Rights Reserved



Parker Hannifin Corporation
 Hydraulic Valve Division
 520 Ternes Avenue
 Elyria, Ohio, USA 44035
 Tel: (440) 366-5200
 Fax: (440) 366-5253
 www.parker.com/hydraulicvalve

Bulletin HY14-2701-B1/US,
 3C, 3/04, PHD