

# LPA2 & PML2

SERIES 30

**TWIN LASER PARTICLE COUNTERS**  
WITH - WATER SATURATION LEVEL  
AND TEMPERATURE SENSOR OPTIONS



- **Online and inline options available.**
- **Complete range of test options.**
- **Automatic on-line continuous test facility.**
- **Variable time & test programmes.**
- **Remote operating capability.**

- Phosphate ester compatible product available.
- Optional bottle sampling package.
- Windows® based software package included.

# LPA2 & PML2

The experience of designers and users of hydraulic and lubrication systems is that 75% of system failures are as a direct result of contamination. Knowing the cleanliness level of the fluid is the basis for contamination control.

## Exclusive MP Filtri technology.

The combination of the two lasers with the unique optics and photodiode package enables the LPA2 & PML2 to give ultra accuracy combined with excellent repeatability.

### W - Option

Water Saturation level (RH %) and fluid temperature sensor option.

## Hydraulic System Component Cleanliness Levels

System component	Typical Cleanliness Specification									
Servo valve			●	●	●					
Proportional valve				●	●	●				
Variable pump					●	●	●			
Cartridge valve						●	●	●		
Gear pump						●	●	●		
Vane pump							●	●	●	
Pressure/flow control valve							●	●	●	
Solenoid valve							●	●	●	
ISO cleanliness	12/10/7	13/11/8	14/12/9	15/13/10	16/14/11	17/15/12	18/16/13	19/17/14	20/18/15	
NAS cleanliness	1	2	3	4	5	6	7	8	9	

## Laser 1

A single point high accuracy laser measures particles of contamination at 4µm(c) and 6µm(c) giving ultra accuracy with excellent repeatability.

## Laser 2

Standard accuracy laser specifically designed for system contaminants between 6µm(c) and 68µm(c).

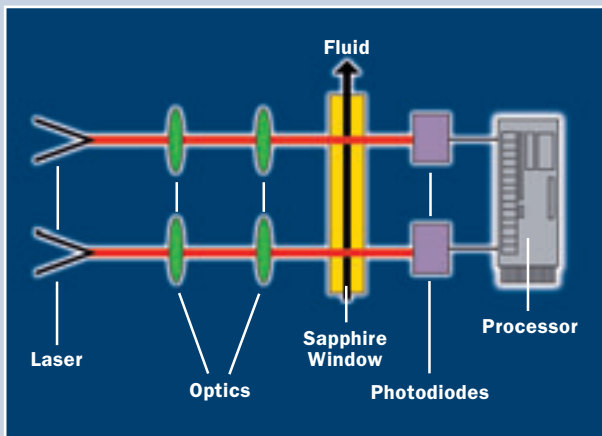

The LPA2 gives accurate results of the amounts and sizes of contaminants - instant results. LPA2 is calibrated with ISO Medium Test Dust (MTD) based on ISO 11171:1999 calibration standard. The new MTD has a certified distribution standard verified by NIST (National Institute of Standard and Technology), USA. The LPA2 is designed to meet the new ISO 4406 cleanliness classification code which is a 3-part code, 4µm(c), 6µm(c) and 14µm(c). The LPA2 also provides results in the NAS 1638 and the SAE4059 code.

## LPA2

- On line, continuous, & automatic test options
- Portable
- Lightweight
- Strong single case
- "QWERTY" Keyboard
- External alarm socket
- ISO 4406
- NAS 1638
- SAE 4059



## PML2

## PML2-W



# LPA2 P

## PARTICLE COUNTER

### SERIES 30

## Twin Laser System.

**A unique high accuracy, fully portable product.  
For users of hydraulic, lubrication and transmission systems.**

**The LPA2 is a highly accurate, portable laser particle analyser that counts and sizes particles of solid contaminants in fluid power systems - on-line to 400 bar, typical test times from 1 minute.**

**For Mineral Oil Products - operating on-line the following option is available**

- Moisture Sensor-measuring percentage saturation of water. - %RH (relative humidity).
- Fluid temperature measurement.



# LPA2 & PML2

## Features

- **The LPA2 is a single case, lightweight product.**

The LPA2 is a robust and rugged, fully portable user friendly instrument, particularly useful in field applications where "ease of use" is fundamental.



Extendable feet allows easy viewing of display screen

- **External alarm socket.**

A plug in adaptor (supplied) which allows an external alarm/indicator to be attached.

- **Language options as standard.**

The LPA2 offers 4 language options as standard (English, Italian, French & German).

- **Monitor + keyboard**

The LPA2 features a large LCD screen with a full size QWERTY keyboard, displaying both ISO 4406, NAS 1638 and SAE 4059 code results.



- **On-line Testing to 400 bar pressure.**

- **Phosphate ester compatible products available.**

- **Thermal printer + RS 232.**

The LPA2 provides a complete printout of results, reporting either in ISO, NAS and SAE codes. These results can be downloaded by RS 232 computer connection.



- **Power (100 + test).**

The LPA2 incorporates a large capacity rechargeable battery, which can be recharged with 12/24 volt power supply. The LPA2 will perform in excess of 100 tests before recharging is required.

- **Data storage 600 test.**

- **Minimess connections.**

The LPA2 uses standard minimess connections (M16 x 2) to the hydraulic system.

- **Electrically operated flush valve.**

The LPA2 features an inbuilt flush valve to ensure that each test is a representative sample of the fluid, and that no cross-contamination between tests occurs. With the LPA2 in the continuous mode the flushing cycle is programmed to commence prior to the test, providing an in-line system test condition.

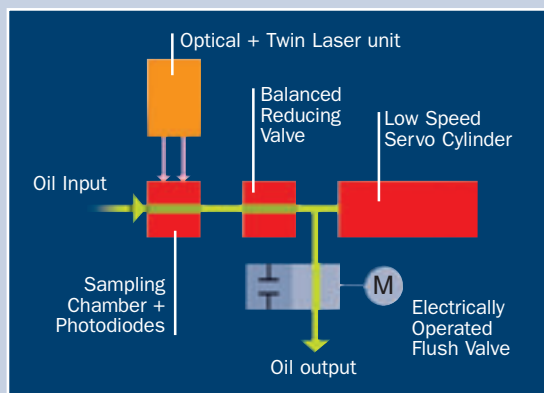

LPA2 - operation.

**Features**

• **Technology. The LPA2 uses a revolutionary design**

The patented fluid handling concept enables it to be use on hydraulic systems up to 400 bar working pressure, however the product has a single action constant low pressure pumping unit to ensure that steady state flow is achieved for every test.

**The LPA2 & PML2 is calibrated with ISO MTD based on ISO 11171.**

**The correlation between particle sizes of ACFTD (old standard) to ISO MTD (new standard) is a follows:**

ACFTD (old standard)	ISO MTD (new standard)
1	4
5	6
15	14
25	21
30	25
50*	38
75*	50
100*	68

\* Yet to be confirmed by NIST.

• **The LPA2 incorporates various test options.**

• **ON-LINE (to 400 bar)**

**1 - Short test**

Test result in 1.5 min., total test time 2.5 min.

**2 - Normal**

Test result in 2.5 min., total test time 4.5 min.

**3 - Dynamic**

3 test with result average, total test time 9.5 min.

**4 - Continuous**

User definable test times and target cleanliness, evels can be set in accordance with requirements. Shortest continuous test time 5 min.

**5 - An electrical plug socket is provided for external alarm signal applications.**

• **BOTTLE SAMPLING**

3 test and results average, test results 4½ min.



• **Hard copy results.**



**1 Online-normal**  
Single test result.  
ISO 4406 code.



**2 Online-dynamic**  
Three test & result average.  
NAS 1638 code.



**3 Online-dynamic**  
Three Test & Result Average.  
ISO 4406 code.

# LPA2 & PML2

## Features

### • Remote operation.

By RS 485 interface, please contact MP Filtri for full details.

### • Accreditation.

The LPA2 is CE marked and supplied with an EMS acceptance certificate.

### • Maximum protection against environmental hazards...

The LPA2 case has a special extrusion to take an environmentally sealed mounting panel providing protection against dust and moisture thus allowing safe operation in the field.



### • Carry Bag accessory.

A strong lightweight carry bag is available which allows the LPA2 with accessories to be carried easily on-site.



### • Optional screen filter.



Recommended for heavily contaminated systems.

### • Bottle Sample Kit Contents:

- Case
- Bottle sampler unit
- Power Supply
- Vacuum Cap
- Sampling Hose 400 mm
- Pressure Hose 1500 mm
- Samples Bottles x 3
- Disposable Tubes x 50
- Hand Pump and Hose x 10 metre
- Waste Bottle and Hose x 2 metre
- Printer paper x 2 Rolls
- Test point Adaptor



### • Standard Sampling Kit Contents:

- Case
- Pressure Hose 1500 mm
- Power Adaptor
- Waste Bottle and Hose x 2 metre
- Printer paper x 2 Rolls
- Test point Adaptor



### • Moisture sensor

The LPA<sup>2</sup> version fitted with the optional moisture sensor module allows both measurement of % saturation of water in oil (Relative Humidity) and temperature.

These are displayed as RH % and °C on the main/test progress screen and on the printed results.

Temperature measurement provides a reference temperature for the RH reading.

**Due to the temperature gradient existing between the System tapping point and the RH/temperature module, the temperature reading can be 5°C to 10°C less than the actual system temperature, depending on operating conditions.**

## Bottle sampling 110 ml and 250 ml options

Dedicated versions available for mineral oil and phosphate ester applications.



110 ml standard bottle sampler unit incorporates de-aeration facility. Suitable for mineral oil applications only.



250 ml laboratory bottle sampler unit incorporates de-aeration facility. Suitable for both mineral oil and phosphate ester applications.



View of 110 ml bottle sampler

A simple selection of the correct switch will enable the user to choose between **Vacuum** for de-aeration or **Sample** to carry out analysis of the bottle sample.

A highly aerated fluid may lead to inaccurate result when analysed, therefore a de-aeration facility has been incorporated into the bottle sampling units. By evacuating the sampling chamber aeration within the fluid is removed and the fluid is conditioned prior to sampling. Any entrained or free air in the oil media at time of bottle Sampling may be shown as part of the particle count. This would lead to inaccuracies of the cleanliness results. As air can be seen as a contaminant. An example of the difference between an aerated sample and a non aerated sample can be seen in this picture.



It is essential that only sample bottles which have been cleaned to ISO 3722 standard are used. Modern hydraulic systems featuring highly effective filters have fluid cleanliness levels that approach that of the sample bottle itself. The use of un-cleaned bottle can greatly increase the particle counts. ( Please note sterilisation kills bacteria but does not remove particles). Perhaps of even greater concern is the variability in their levels of cleanliness. A sudden increase in contamination could be caused by the sample bottle. This apparent increase could instigate unnecessary corrective action.

**Information taken from BFP/A/P5 paragraph 7.6.2 Sample bottles.**

MP Filtri UK can supply laboratory standard sample bottles. Part No: .P. 02. These have been cleaned in accordance with DIN/ISO 5884.

The degree of cleanliness has been verified to ISO 3722 with a NAS 1638 cleanliness certification of between Class 00 and Class 0.

**The W moisture sensor is not suitable for bottle sampling**

# LPA2 & PML2

## PML2 Series 30 and Series 31

## PML2-W Series 30 and Series 31

- **Design 30:** Inlet pressure: 2 bar to 400 bar  
Drain reservoir/system: Atmospheric, zero back pressure
- **Design 31:** Inlet pressure: 10 bar to 400 bar  
Drain reservoir/system: Back pressure not exceeding 1 bar

### • In-line particle counter Series 30 and Series 31.

The permanent in-line twin laser particle counter is designed for all hydraulic applications, where continuous monitoring is essential. The PML2 incorporates the LPA2 technology and is designed to work continuously and automatically in most hydraulic industries and applications:

The unit contains a pressure switch (not available with Skydrol models), which only permits operation when there is sufficient pressure in the PML2.

### • PML2 Features

- Cast aluminium powdered coated case
- Continuous self diagnostics
- Standard RS 232
- Eight channel analysis
- ISO 4406, NAS 1638, SAE 4059
- Test time flexibility
- Operation by laptop or specified customers protocol
- Permanently installed

### • For mineral oil products.

- Moisture Sensor-measuring percentage saturation of water. - % RH (relative humidity)
- Fluid temperature measurement.

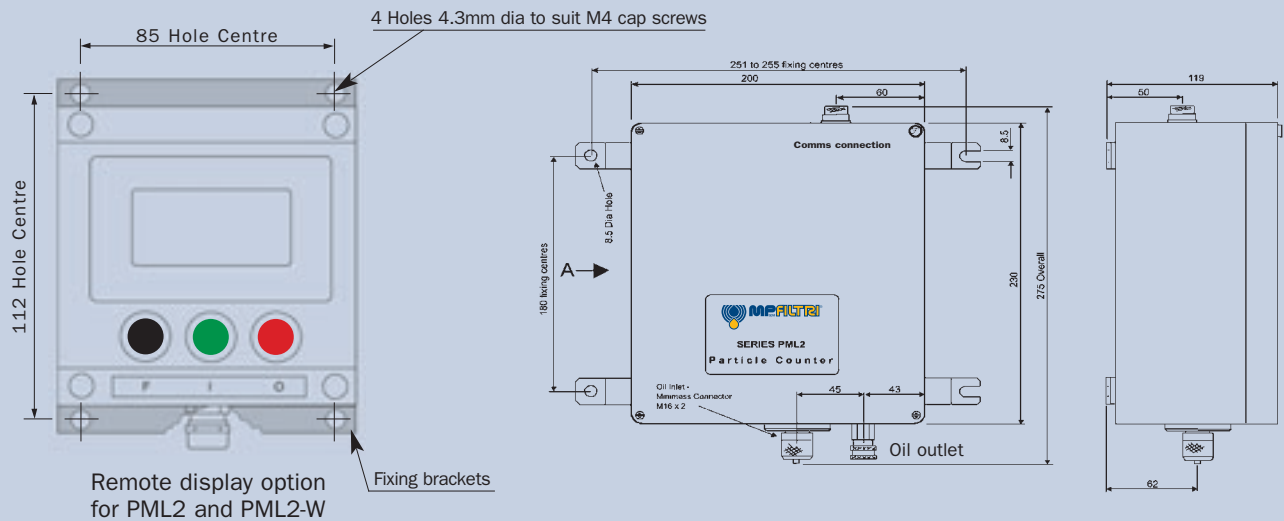



• **Software.**

Full system trend analysis is available within the accompanying Windows® based software package.

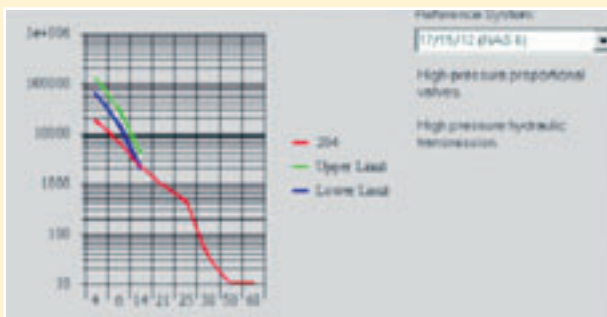
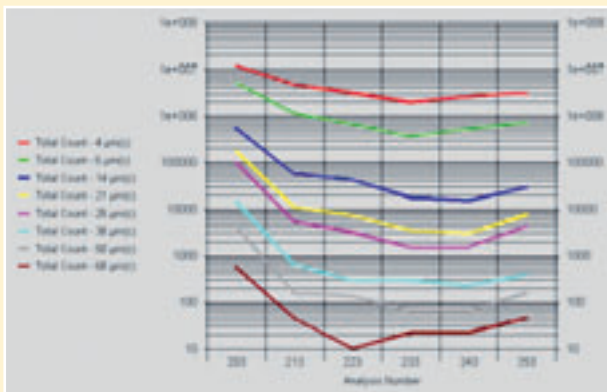
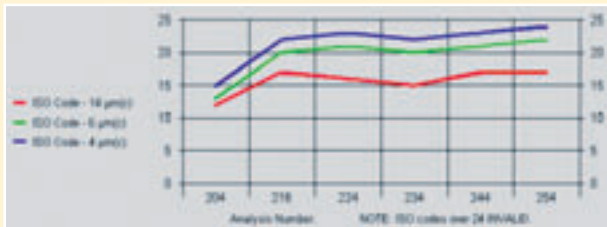

- CD and interface supplied with LPA & PML for downloading of data to PC.
- Data can be imported and exported to other windows based programmes.
- Long term service records and trend analysis can be monitored.
- Quick and simple filter-keys for easy-to-read selected data.
- Comprehensive contamination analysis report generator.
- Comparison graphs for selected cleanliness codes reference and actual readings taken.
- Other protocols available on request.

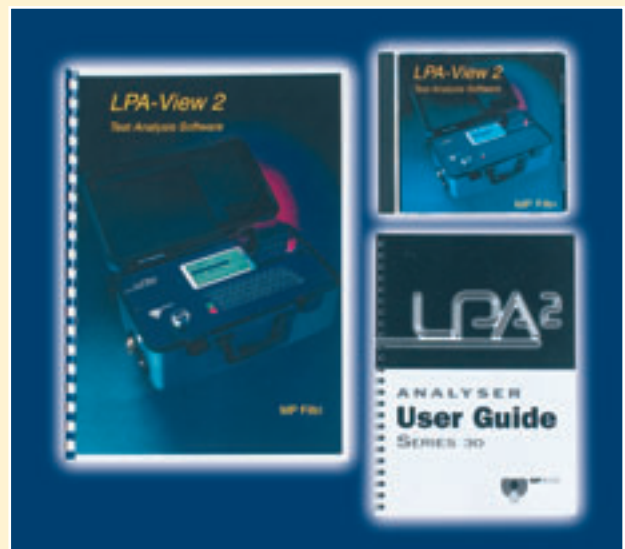

# Specification LPA2

<b>Technology</b>	Automatic optical particle analyser
<b>Laser package</b>	Twin laser and twin optical diode detectors
<b>LCD display</b>	(back lit)
<b>Sensitivity</b>	>4,6,14,21,25,38,50,68,µm(c), micron range to revised ISO 4406 Standard
<b>Accuracy/repeatability</b>	Better than 3% typical
<b>Calibration</b>	Each unit is individually calibrated with ISO Medium Test Dust (MTD) as based on ISO 11171:1999.
<b>Analysis range</b>	ISO 8 to ISO 24, ISO 4406 Code. (NAS 1638 Code - 2 to 12) (SAE AS 4059- Code 2 to 12)
<b>Report/print format</b>	ISO and NAS codes, with optional individual particle counts
<b>Printer</b>	Fixed head thermal printer 384 dots per line.
<b>LPA2 sample volume</b>	8 ml. (short), 15 ml. (normal), 30 ml. (dynamic), 24 ml. (bottle sampler), 15 ml. (continuous)
<b>Operation</b>	Max. system working pressure - 400 bar. Min. working pressure - 2 bar.
<b>Viscosity range</b>	to 400 centistokes
<b>Operating temperature</b>	+ 5 to + 80°C
<b>Fluid compatibility</b>	Mineral oil & petroleum based fluids, and Skydrol® (consult MP FILTRI for other fluids)
<b>Typical test time</b>	2 mins.
<b>Power</b>	Internal rechargeable battery (mains charger) or external 12/24 volt DC power supply.
<b>Data storage</b>	600 tests
<b>Computer interface</b>	RS 232 communication port
<b>Hose connections</b>	Microbore pressure hose 1.5 m long with minimes fittings (5 m & 10 m lengths available). Quick coupling waste hoses.
<b>Dimensions</b>	Height 210 mm. Depth 260 mm. Width 430 mm. Weight 7.6 kilos
<b>Built in optional product</b>	-W- Moisture sensor measures RH% - relative humidity. Accuracy +or-3% and fluid temperature in °C - accuracy + or - 3°C
<b>Optional Product</b>	In line coarse screen unit minimes fitting. 500 micron st.steel cleanable mesh 400bar filter pressure.

Patent app. no. 2354067 - As a policy of continual improvement. MP FILTRI reserve the right to alter the specification without prior notice.

### How to order

LPA2  
Standard  
Product

LPA2-W  
with  
moisture  
sensor

M

S

X

30

UK

**Product**

<b>M</b>	Mineral oil	<b>S</b>	Phosphate ester *
<b>S</b>	Standard unit c/w case	<b>C</b>	Standard unit c/w case carry bag
<b>X</b>	Without bottle sampling	<b>1B</b>	Bottle sampling unit 110ml c/w case
		<b>2B</b>	Bottle sampling unit 250ml c/w case

**Design Ref.**

<b>UK</b>	Power Supply	<b>EU</b>	Power Supply	<b>US</b>	Power Supply
-----------	--------------	-----------	--------------	-----------	--------------

Example: **LPA2 - M - S - X - 30 - UK** (LPA2 Standard)  
LPA2 is supplied with a full software package

	Optional Products
<b>Bottle Sampling / De aeration Unit 110ml</b>	BS - LPA - M - 110 - *
<b>Bottle Sampling / De aeration Unit 250ml (Mineral Oil)</b>	BS - LPA - M - 250 - *
<b>Bottle Sampling / De aeration Unit 250ml (Skydrol)</b>	BS - LPA - S - 250 - *
<b>USB to serial port converter</b>	SK0026
<b>Software Package</b>	LPA - W - 30
<b>Carry Bag</b>	CB0001
<b>In line Coarse Screen filter</b>	SK.0040

\* State either **UK**, **EU** or **US** power supply.

**The LPA2 Analyser**

Includes accessories package - hoses, waste bottle, printer paper and ribbon, M 16x2 to BSP adaptor.

\* The Phosphate Ester product with moisture sensor is not currently available. Please contact MP FILTRI

# Specification PML2/PML2-W

<b>Technology</b>	Automatic optical particle analyser
<b>Laser package</b>	Twin laser and twin optical diode detectors
<b>Sensitivity</b>	>4,6,14,21,25,38,50,68,µm(c), micron range to revised ISO 4406 Standard
<b>Accuracy/repeatability</b>	Better than 3% typical
<b>Calibration</b>	Each unit is individually calibrated with ISO Medium Test Dust (MTD) as based on ISO 11171:1999.
<b>Analysis range</b>	ISO 8 to ISO 24, ISO 4406 Code. (NAS 1638 Code - 2 to 12) (SAE AS 4059- Code 2-12)
<b>PML2 sample volume</b>	15 ml.
<b>Operation</b>	Max. system working pressure - 400 bar. Min pressure - 2 bar. (Series 30) - 10 bar. (Series 31)
<b>Viscosity range</b>	to 400 centistokes
<b>Operating temperature</b>	+ 5 to + 80°C
<b>Fluid compatibility</b>	Mineral oil & petroleum based fluids, and Skydrol® (consult MP FILTRI for other fluids)
<b>Typical test time</b>	2 mins.
<b>Power</b>	12/24 volt DC power supply.
<b>Data storage</b>	600 tests
<b>Computer interface</b>	RS 232 communication port (Standard)
<b>Hose connections</b>	Microbore pressure hose 1.5 m long with minimes fittings (5 m & 10 m lengths available). Quick coupling waste hoses.
<b>Dimensions</b>	Height 120 mm - Length 275 mm - Width 250 mm - Weight 4.8 kilos
<b>Built in optional product</b>	- W- Moisture sensor measures RH% - relative humidity. Accuracy +or-3% and fluid temperature in °C - accuracy + or - 3°C
<b>Optional Product</b>	In line coarse screen filter minimes fitting. 500 micron st.steel cleanable mesh 400bar filter pressure.

Patent app. no. 2354067 - As a policy of continual improvement. MP FILTRI reserve the right to alter the specification without prior notice.

### How to order

<b>Product</b>	PML2 Standard Product	PML2-W with moisture sensor	<b>M</b>	<b>D</b>	<b>1C</b>	<b>30/31</b>	<b>UK</b>	
<b>M</b> Mineral oil	<b>S</b> Phosphate ester *							
<b>D</b> Display module options (see right)	<b>X</b> Customer specified display (eg Modbus)							
<b>1C</b> RS 232	<b>2C</b> RS 485							
<b>30</b> Design 30: Inlet pressure: 2 bar to 400 bar Drain reservoir/system: Atmospheric, zero back pressure								
<b>31</b> Design 31: Inlet pressure: 10 bar to 400 bar Drain reservoir/system: Back pressure not exceeding 1 bar								
<b>UK</b> Power Supply	<b>EU</b> Power Supply	<b>US</b> Power Supply For "D" options only						

**Display module options**

- D2** Remote Module + PC Driven\*
- D3** PC Driven\*
- D5** Remote Visual Indicator (Red/Green) + PC Driven\*

**The PML2 Analyser**  
Includes accessories package - hoses

Example: **PML2 - W - M - D2 - 1C - 30 - UK**

**Notes**

- 1 PC Driven units (D2, D3, D5) use MP FILTRI Proprietary software (LPA View) and software is included.
- 2 Note: Connecting cable is 0.5 metre max.
- 3 A power supply is supplied with the "D" options.
- 4 For MODBUS versions, the user manual is provided, for use with the customers own software programme.  
**The standard MODBUS Protocol setting/options are:**  
Protocol Type: RTU  
Baud Rate: 57600\* or 115200\*. Other Baud rates available on request.  
Parity: Even  
Signal type: RS232 preferred. RS485 available on request.  
Node Address: 4  
Choose Baud rate required.
- 5 Phosphate Ester product with moisture sensor is not currently available. Please contact MP FILTRI.

## LPA2-W and PML2-W Contamination and Moisture and Temperature

The LPA2-W and PML2-W provides accurate and repeatable measurement of the % saturation of water. RH (relative humidity) Different oils have different saturation levels and % saturation is the best and most practical measurement. These results can be converted to PPM (parts per million), if the oil type saturation/temperature characteristic is known.

### Measuring water in hydraulic and lubricating fluids

(from North Notts Fluid Power Centre)

## WATER CONTENT

In mineral oils and non aqueous fire resistant fluids water is undesirable. Mineral oil usually has a water content of 50-300 ppm which it can support without adverse consequences.

Once the water content exceeds about 500ppm the oil starts to appear hazy. Above this level there is a danger of free water accumulating in the system in areas of low flow. This can lead to corrosion and accelerated wear.

Similarly, fire resistant fluids have a natural water content which may be different to mineral oil.

### Saturation Levels

Since the effects of free (also emulsified) water is more harmful than those of dissolved water, water levels should remain well below the saturation point. However, even water in solution can cause damage and therefore every reasonable effort should be made to keep saturation levels as low as possible.

There is no such thing as too little water. As a guideline, we recommend maintaining saturation levels below 50% in all equipment.

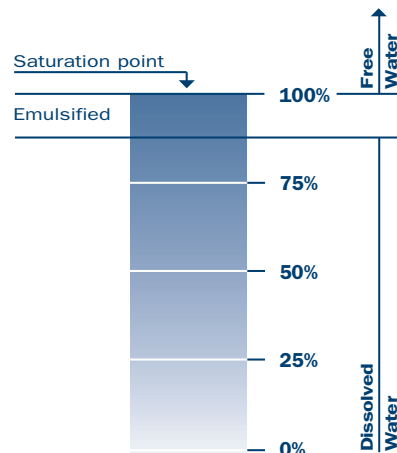

### Typical Water Saturation Levels - For new oils

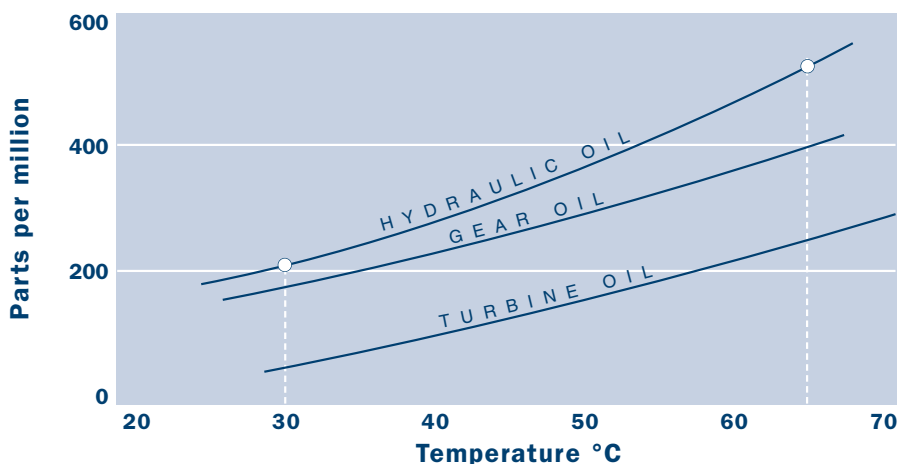

Examples: Hydraulic oil @ 30°C = 200ppm = 100% saturation  
 Hydraulic oil @ 65°C = 500ppm = 100% saturation

# LPA2 & PML2

For complete information on the LPA2 and PML2 products please visit website: [hydraulicparticlecounter.com](http://hydraulicparticlecounter.com)

## Applications and testimonials



### • The LPA2 Applications in Industry.

**Service** – Accurate monitoring of systems reduces costs attributed to manpower and material shortcomings.

**Quality Control** – Certifies products to a recognised cleanliness standard.

**Condition Monitoring** – Allows accurate monitoring of high cost processes & installations ensuring system reliability.

**Maintenance Operations** – Used in predictive & preventative maintenance routines to monitor and investigate equipment performance.

**Military Applications** – Accurate system monitoring and performance ensures confidence in a hostile environment.

**Production Development** – The ability to define a specified cleanliness code for manufactured products to customers of hydraulic systems.

### • Typical Applications

- Steel Mills
- Paper Mills
- Injection moulding
- Automotive
- Wind Power
- Test Benches
- Lubrication
- Roll Off cleanliness
- Power packs



- The Lufthansa Technik AG hydraulic test centre located in Hamburg, uses the LPA2 for analysis of hydraulic fluids of its Skydrol test benches.



- Prior to completion, each Extec machine is flushed. The LPA2 is used to ensure that the hydraulic systems meet with the required standards



- **DARA** (Defence Aviation Repair Agency) have completed a state of the art Aircraft Servicing Facility at St Athan Wales.

System contamination monitoring is achieved by using an in-line particle counter (PML2) on each service module.

A “Modbus” protocol enables the PML2 to be programmed to communicate with a Programmable Logic Controller. (PLC). This measures and reports the cleanliness of the various aircraft hydraulic systems.



PML2 In-line Particle Counter

**Head Quarter:****MP FILTRI S.p.A. Italy**

Via 1° Maggio, 3  
20060 Pessano con Bornago (Milano) Italy  
Tel. +39.02.95703.1  
Fax +39.02.95741497-95740188  
sales@mpfiltri.com  
www.mpfiltri.com

**GREAT BRITAIN****MP FILTRI U.K. Ltd.**

Bourton Industrial Park  
Bourton on the Water  
Gloucestershire GL54 2HQ  
Phone: +44.01451-822522  
Fax: +44.01451-822282  
sales@mpfiltri.co.uk  
www.mpfiltri.co.uk

**GERMANY****MP FILTRI D GmbH**

Am Wasserturm 5  
D-66265 Heusweiler-Holz  
Phone: +49.06806-85022.0  
Fax: +49.06806-85022.18  
service@mpfiltri.de  
www.mpfiltri.de

**FRANCE****MP FILTRI FRANCE**

B.P. 65  
74501 Evian Cedex  
Phone: +33.04-50-71-64-80  
Fax: +33.04-50-71-73-32  
mpfiltrifrance@wanadoo.fr

**USA****MP FILTRI USA Inc.**

2055 Quaker Pointe Drive  
Quakertown, PA 18951  
Phone: +1.215-529-1300  
Fax: +1.215-529-1902  
sales@mpfiltriusa.com  
www.mpfiltriusa.com

**CANADA****MP FILTRI CANADA Inc.**

380 Four Valley Drive  
Concord-Ontario L4K 5Z1  
Phone: +1.905-303-1369  
Fax: +1.905-303-7256  
mail@mpfiltricanada.com  
www.mpfiltricanada.com

**RUSSIAN FEDERATION****MP FILTRI RUSSIA**

Sergeya Makeieva str. 9,  
Building 2, office 15,  
123100 Moscow  
Phone: +7.095-502-5411  
Fax: +7.095-205-9410  
P.O. Box 44 127562 Moscow  
mpfiltrirusia@yahoo.com  
www.mpfiltri.ru

**CHINA****MP FILTRI**

P.O. Box 418-008  
Shanghai  
Phone: +86.21-57120700  
Fax: +86.21-57127200  
sales@mpfiltrichina.com