

SPECIFICATIONS

Body	Carbon steel
Ball	Carbon steel
Temperature Range	-4°F to 212°F (depending on seal material selected)
Ball Seats	Delrin (Standard) POM, PEEK PA612, GEMPTFE, PTFE (Optional)
O-Rings	Buna N (Standard) FKM, EPDM, MVQ (Optional)

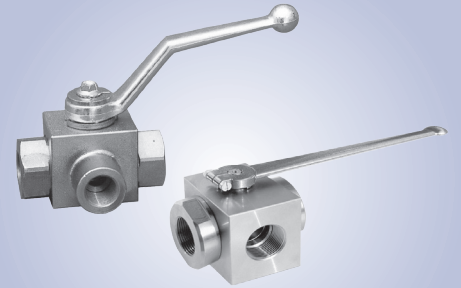

GE3 / GB3 CARBON

DIMENSIONS

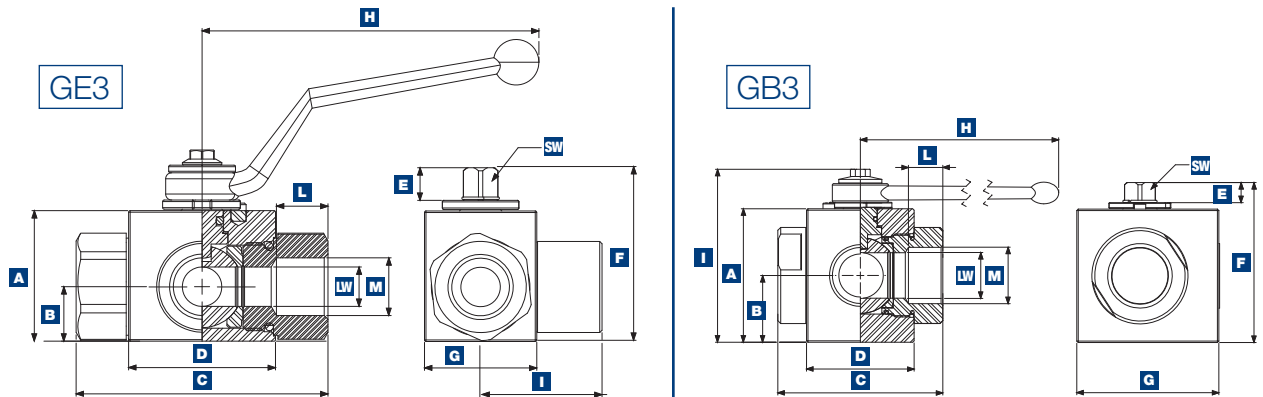

Model	Size	A	B	C	D	E	F	G	H	I	L	M	SW	LW
Full Bore	1/4"	1.38"	0.57"	2.80"	1.67"	0.43"	1.93"	1.18"	4.33"	3.60"	0.67"	1/4"	0.35"	0.24"
	3/8"	1.57"	0.69"	2.87"	1.75"	0.43"	2.14"	1.38"	4.33"	3.80"	0.67"	3/8"	0.35"	0.39"
	1/2"	1.69"	0.71"	3.27"	1.91"	0.43"	2.24"	1.46"	4.33"	3.92"	0.83"	1/2"	0.35"	0.51"
	3/4"	2.17"	0.92"	3.74"	2.46"	0.55"	2.89"	1.77"	7.09"	4.19"	0.83"	3/4"	0.55"	0.79"
	1"	2.56"	1.16"	4.41"	2.62"	0.55"	3.29"	2.17"	7.09"	4.59"	0.94"	1"	0.55"	0.98"
Reduced Bore	1-1/4"	2.56"	1.16"	4.72"	2.62"	0.55"	3.29"	2.17"	7.09"	4.59"	0.94"	1-1/4"	0.55"	0.98"
Full Bore	1-1/4"	3.66"	1.83"	4.53"	2.95"	0.53"	4.39"	3.90"	11.81"	4.74"	0.94"	1-1/4"	0.67"	1.26"
	1-1/2"	4.21"	2.11"	5.16"	3.35"	0.53"	4.94"	4.53"	11.81"	5.30"	0.98"	1-1/2"	0.67"	1.57"
	2"	4.49"	2.24"	5.51"	3.86"	0.53"	5.22"	5.04"	11.81"	5.57"	1.06"	2"	0.67"	1.97"

ORDERING INFORMATION

Model	Part #	Ports	Part #	Ports	Working Pressure	Weight	Locking Kit Part #
Full Bore	GE3 N 1/4"	1/4" NPT	GE3 SAE4	SAE-4	5800 PSI	1.00 lb	GE-LK-6
	GE3 N 3/8"	3/8" NPT	GE3 SAE6	SAE-6	5800 PSI	1.25 lb	GE-LK-6
	GE3 N 1/2"	1/2" NPT	GE3 SAE8	SAE-8	5075 PSI	1.61 lb	GE-LK-6
	GE3 N 3/4"	3/4" NPT	GE3 SAE12	SAE-12	5075 PSI	3.00 lb	GE-LK-20
	GE3 N 1"	1" NPT	GE3 SAE16	SAE-16	5075 PSI	4.80 lb	GE-LK-20
Reduced Bore	GE3 N 1-1/4" R	1-1/4" NPT	GE3 SAE20	SAE-20	5075 PSI	5.25 lb	GE-LK-20
Full Bore	GB3 N 1-1/4"	1-1/4" NPT	N/A	N/A	5075 PSI	8.25 lb	GB-LK
	GB3 N 1-1/2"	1-1/2" NPT	N/A	N/A	5075 PSI	12.75 lb	GB-LK
	GB3 N 2"	2" NPT	N/A	N/A	5075 PSI	14.25 lb	GB-LK